

Product Code

3320/7S

Crankcase Pressure Regulator
7/8"-22mm ODS

CLASSIC

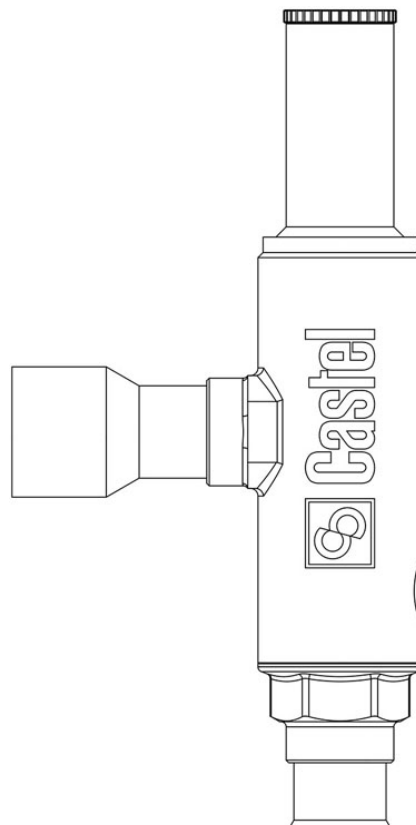

Product use

These are regulators commonly used in low-temperature refrigeration systems. They are designed to prevent the compressor motor from overloading when the intake pressure exceeds the manufacturer's recommended operating pressure.

Accessories for use with the following ASHRAE 34:2019 refrigerants, Class A1:

HCFC (R22)

HFC (R134a, R404A, R407C, R410A, R507)

HFO (R1234ze)

HFO + HFC (R448A, R449A, R450A, R452A, R513A, R515A, R515B)

Product details

Connections SAE Flare -

Connections Ø ODS [in.] 7/8"

Ø ODS [mm] 22

Regulation range [bar] 0,2 - 6

Kv [m³/h] 3,3

PS [bar] 28

MWP [psi] (1) 405

TS [°C] min. - 40

TS [°C] max. + 110

Package pcs 8

Notes

(1): according to UL approval